



Unique

PVC Shower Pan Membrane

UNIQUE PLASTICS CORPORATION

P.O. BOX 108-258 TAIPEI, TAIWAN
TEL: (886-2) 2741-5391
FAX: (886-2) 2776-9998 & 2772-0866
<http://unique-plastics.net>
e.mail: uniquepc@ms14.hinet.net

UNIQUE PLASTICS CORPORATION

1. Shower pan liner is a kind of flexible PVC sheet with special treatment. It features mildew-proofness and alkali-resistance. It can be successively printed with horizontal lines as required by customers. Its qualification property, physical properties specification meet to ASTM-D-4551.

2. Quality Assurance Requirements(By ASTM-D-4551)

No.	Property	Unit	Specification	
			30 GA	40 GA
01	Thickness	in (mm)	0.030 (0.765) min	0.040 (1.02) min
02	Pinholes	number	none	none
03	Shrinkage (at 158° F)	% of original	5% MAX	5% MAX
04	Width	in (cm)	+0.5 (1.27) -0.0	+0.5 (1.27) -0.0

3. Qualification Tests and Physical Properties Specification(By ASTM-D-4551)

No.	Property	Unit	Specification		Test Method
			30 GA	40 GA	
01	Thickness	in(mm)	0.030(0.765)min	0.040(1.02)min	ASTM-D 374
02	Tensile Strength	Lbf/in(KN/m)of width	80(10.45)min	80(14.05)min	ASTM-D 412
03	Tensile Strength at 100% Elongation	Lbf/in(KN/m)of width	30(5.23)min	40(7.03)min	ASTM-D 412
04	Elongation At Break	%	300min	300min	ASTM-D 412
05	Tear Resistance	Lbf/in(KN/m)of width	185(32.5)min	250(43.7)min	ASTM-D 1004
06	Pinholes	number	none	none	ASTM-D 4551 section 11.8
07	Micro-Organism Resistance	Specimen pass/fail	12 of 12 pass	12 of 12 pass	ASTM-D 4551(A1)
08	Puncture Resistance	Specimen pass/fail	6 of 6 pass	6 of 6 pass	ASTM-D 4551(A2)
09	Indentation Resistance	Specimen pass/fail	3 of 3 pass	3 of 3 pass	ASTM-D 4551(A3)
10	Folding Resistance	Specimen pass/fail	3 of 3 pass	3 of 3 pass	ASTM-D 4551(A4)
11	Chemical Resistance: (a) Distilled H ₂ O 120°F (49°C) x 24 hrs	%weight change	+1% MAX	+1% MAX	ASTM-D -543
	(b) Soapy H ₂ O 120°F(49°C) x 24hrs	%weight change	+2%MAX	+2%MAX	
	(c) Alkali 150°F(66°C) x 72hrs	Specimen pass/fail	3 of 3 pass	3 of 3 pass	
12	Hydrostatic Pressure Test	Specimen pass/fail	3 of 3 pass	3 of 3 pass	
13	Shrinkage at 158°F x 1hr	% Original	5% MAX	5% MAX	ASTM-D -1204
14	Volatile loss 158°F x 24hrs	% Loss	1.5% MAX	1.5% MAX	ASTM-D -1203



1. MAKE THE SHOWER FLOOR READY

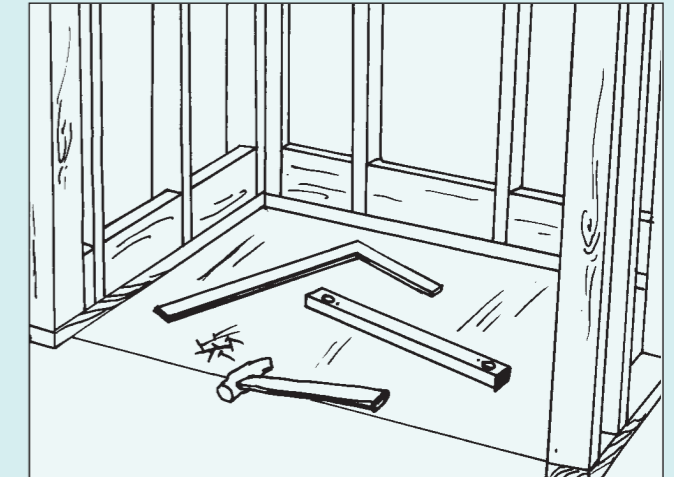

2. BUILD UP THE STALL

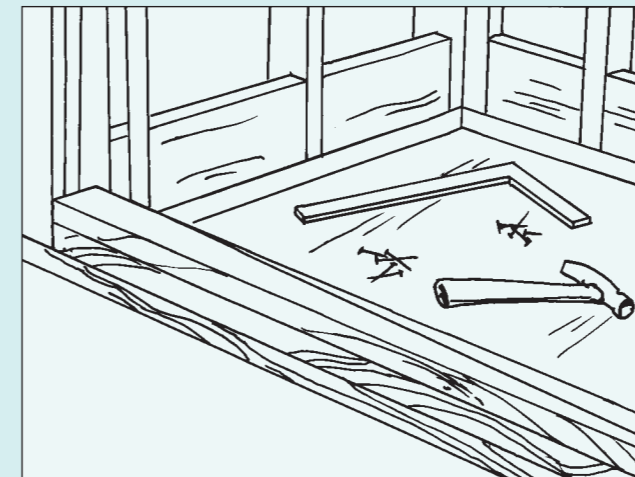

3. MAKE THE THRESHOLD

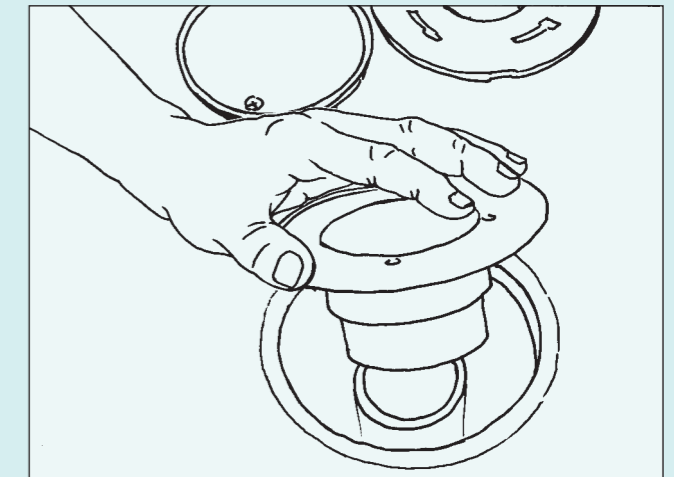

4. INCISE A PROPER HOLE FOR SHOWER DRAIN

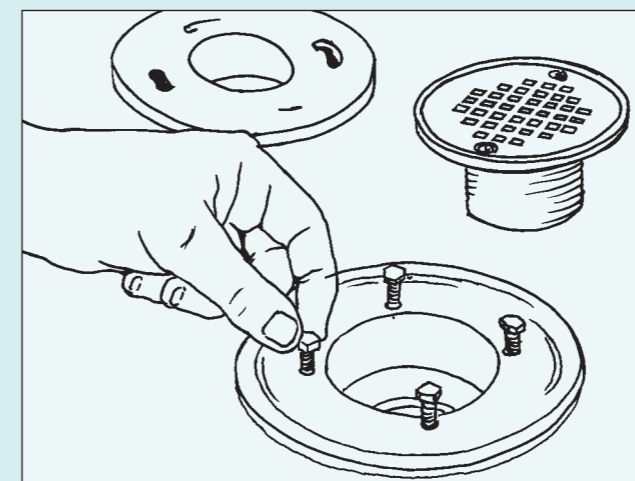

5. THREAD AND MARK BOLTS

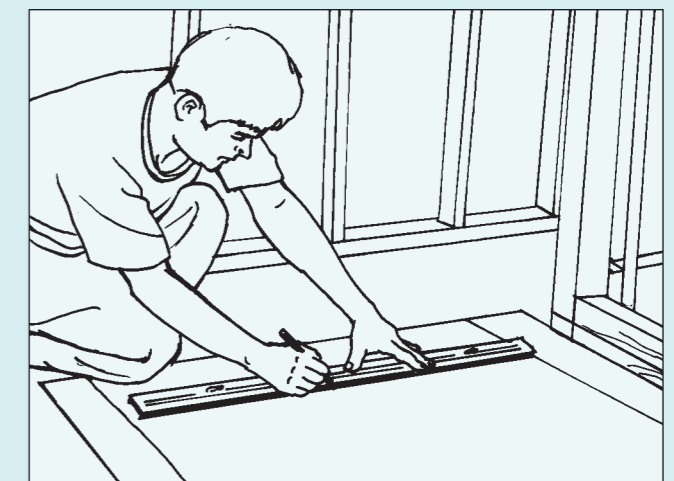

6. ARRANGE PRECISELY

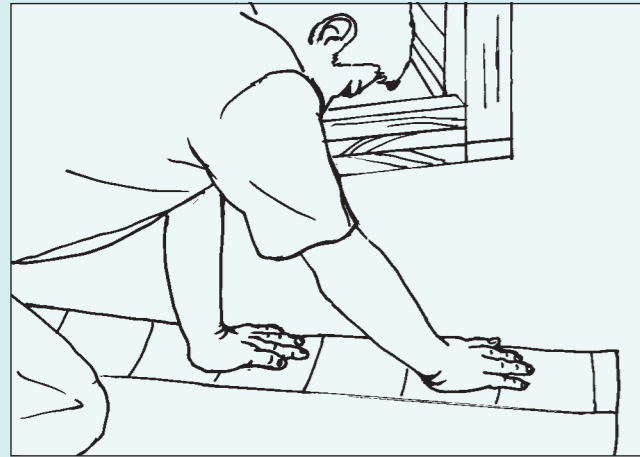

7. CUTTING THE SHEET

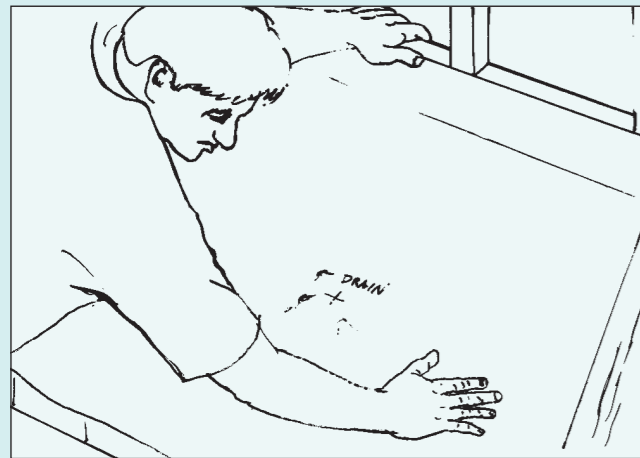

8. SMOOTH THE SHEET

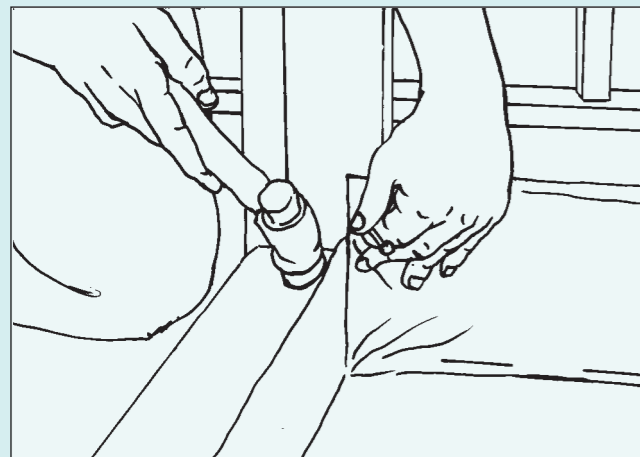

9. CONSTRUCT THE CORNERS

Additional Steps

To seam shower pan membrane (making the basement sheet):

1. All dust, oil, and grease from mating surfaces must be removed.
2. Please use the recommended cleaner or primer to coat both mating surfaces.
3. Wait for primer to dry thoroughly.
4. Uses welding solvent to coat mating surface.
5. Line up surfaces and roll together, after a 1 minute of waiting.
6. Try to separate, after 5 minutes of waiting.
7. Repeat steps 4 to 6 if the seam seems open or unstable.

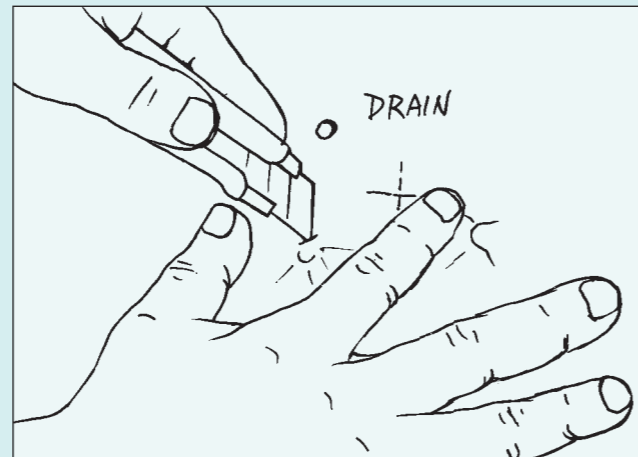
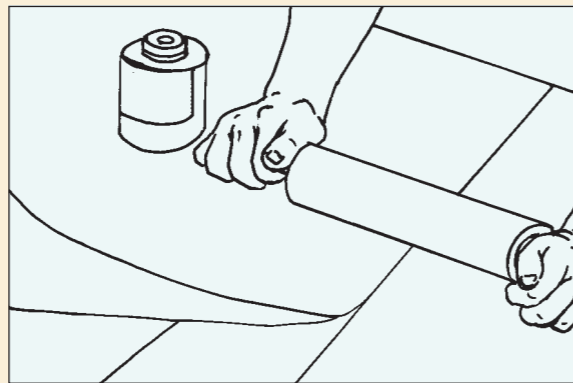

10. EXPLORE THE DRAIN BOLTS

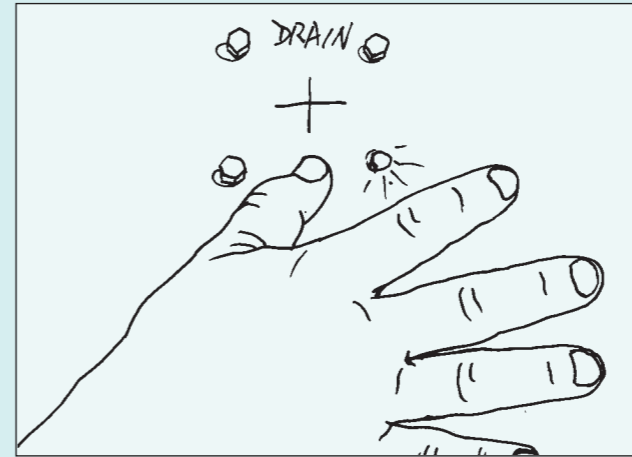

11. STRETCH THE SHOWER PAN MEMBRANE

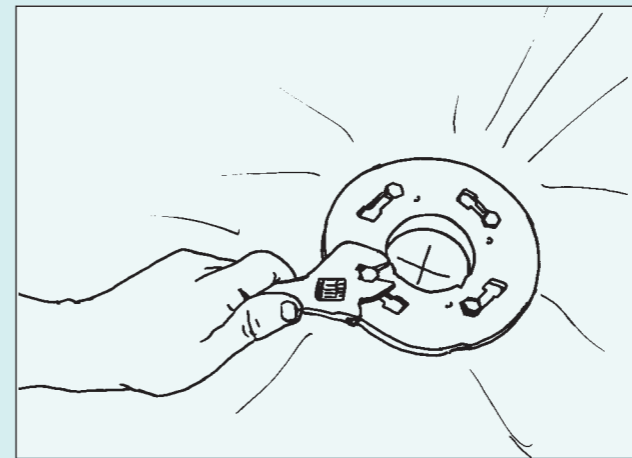

12. LOCK THE CLAMP

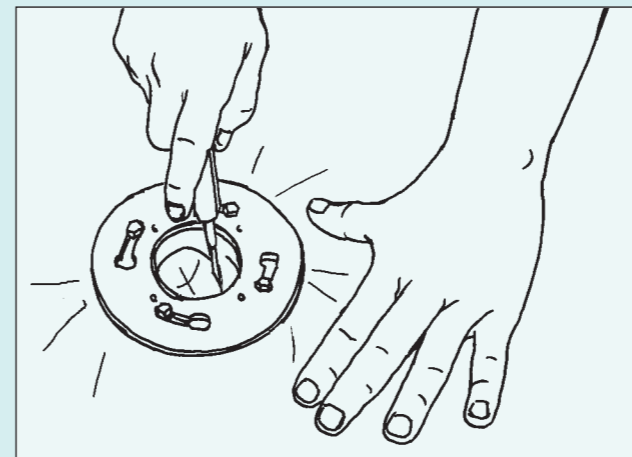

13. REMOVE THE MEMBRANE INSIDE OF THE CLAMP

Additional Steps

How to construct corners:

1. Fold one side of the flap.
2. Fold second side of the flap.
3. In order to join both flaps, make sure you pinching both corners together as a triangle.
4. Press the triangle to one side; then staple in place.

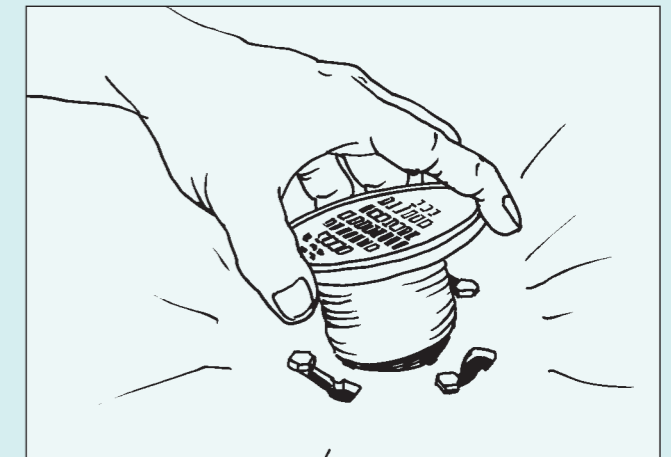
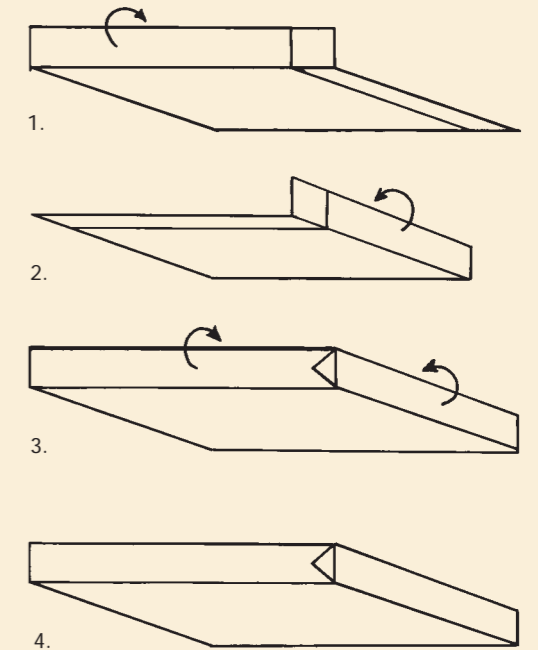

14. COVER AND ROLL UP THE CLAMP

The Guide to Build a Custom Shower Pan

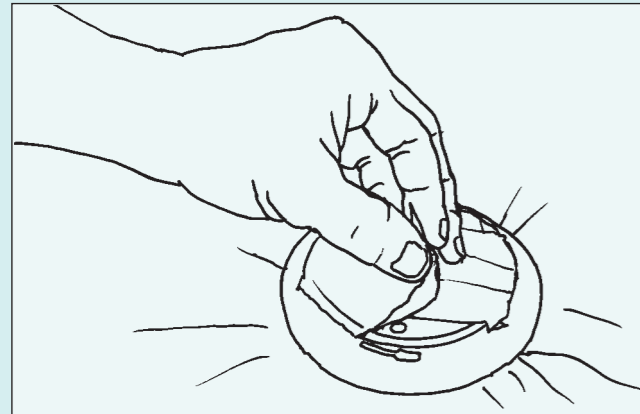

15. COVER THE STAINER WITH TAPE

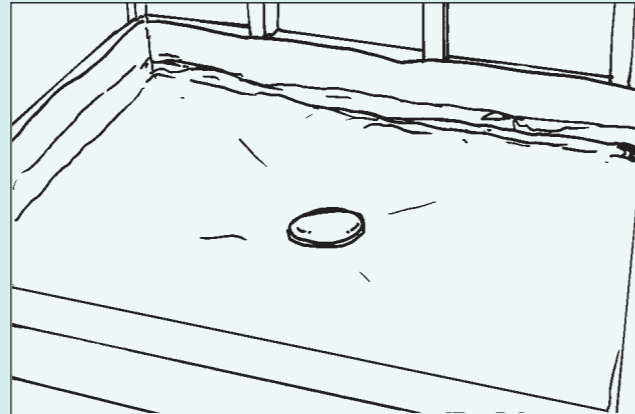

16. FILL THE SHOWER PAN WITH WATER

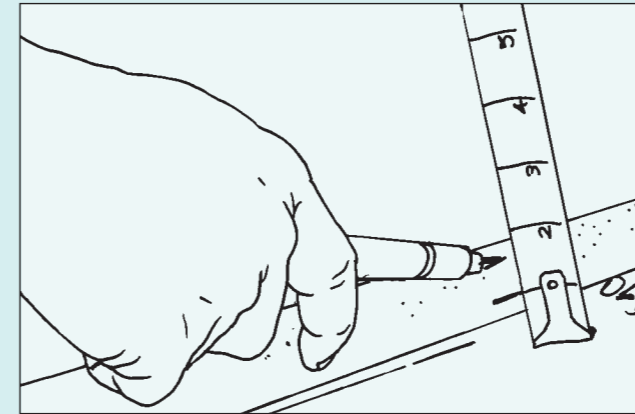

21. MAKE THE SUPPORT BOARD



22. MIX AND DRY MORTAR

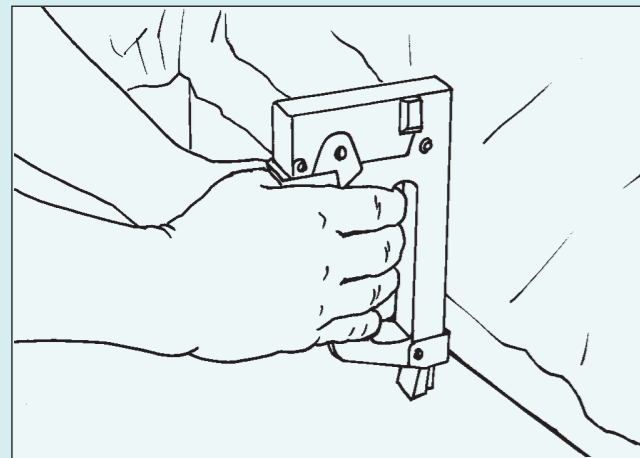

17. OVERLAP THE WALLS WITH POLY

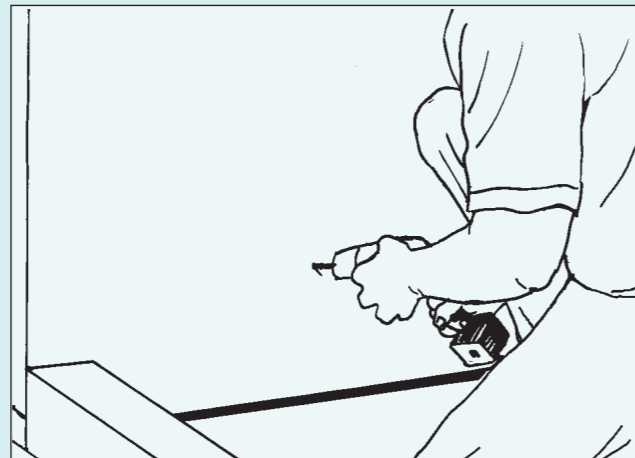

18. FIX THE SUPPORT BOARD

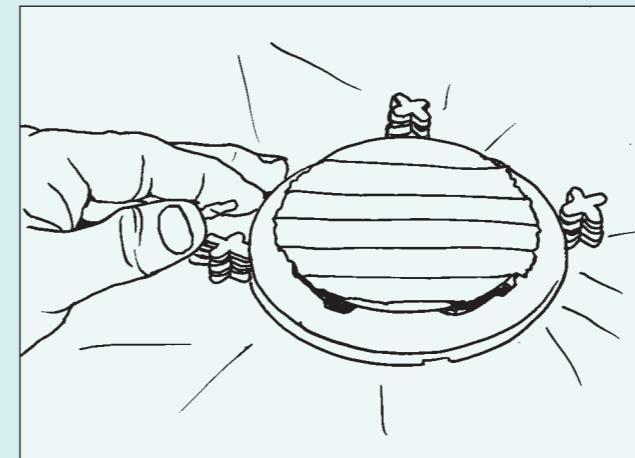

23. MAKE A FEW SPACERS TO PREVENT CLOGGING

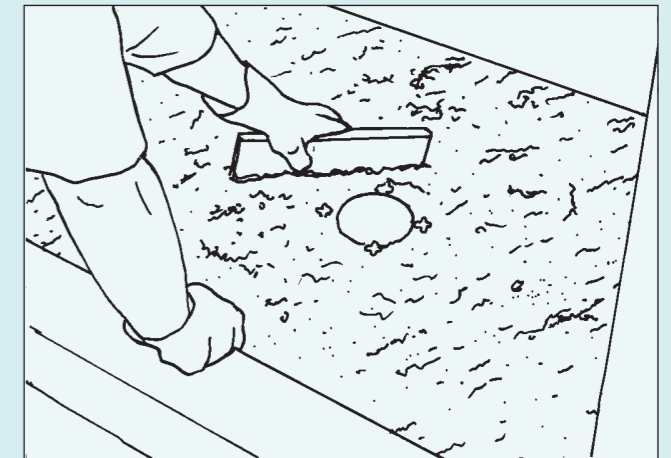

24. USES MORTAR TO FULFILL ALL THE PAN

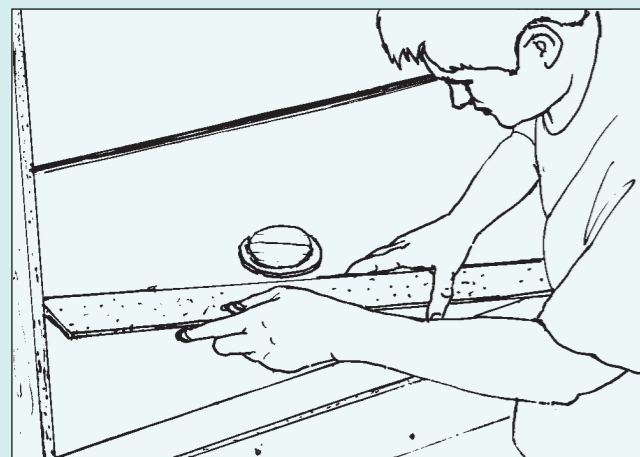

19. FIX SUPPORT BOARD OVER THE CURB

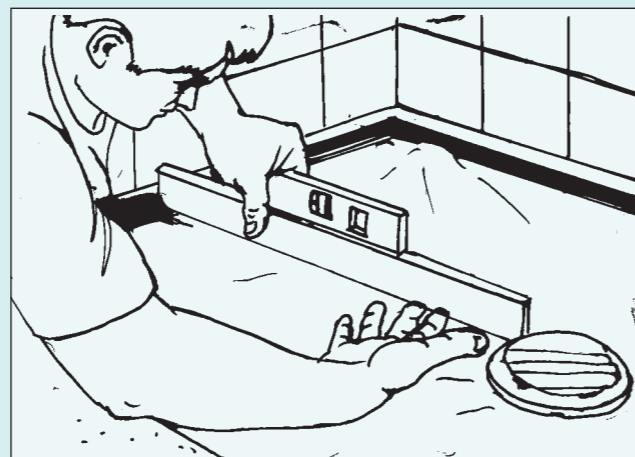

20. MAKE LEVEL

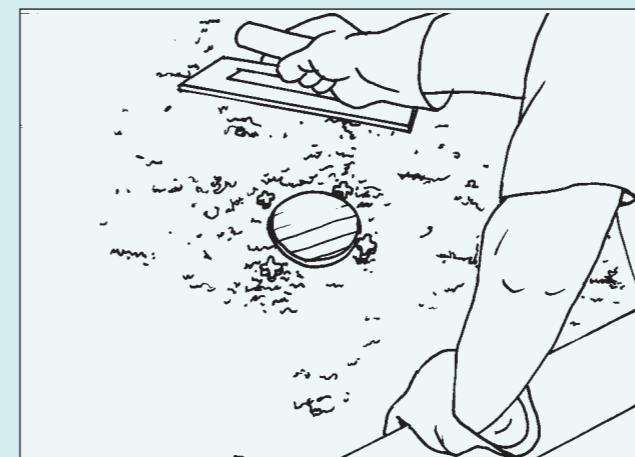

25. COMPLETE THE WORK

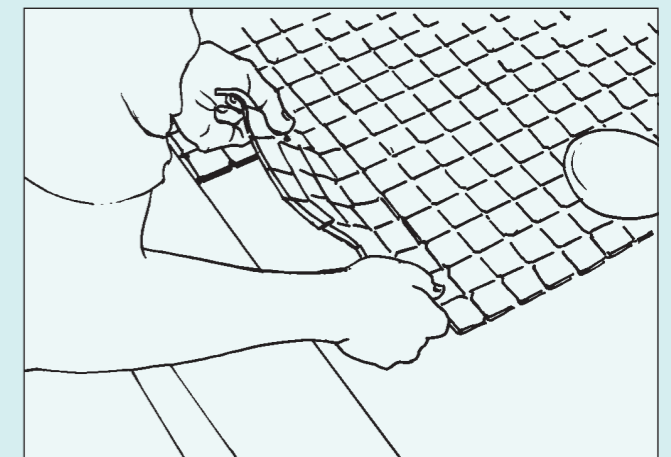

26. PLACE THE TILES